

# Carrier Packaged Outdoor Air-Cooled Liquid Chillers

**30GB**

150, 175 and 200 tons

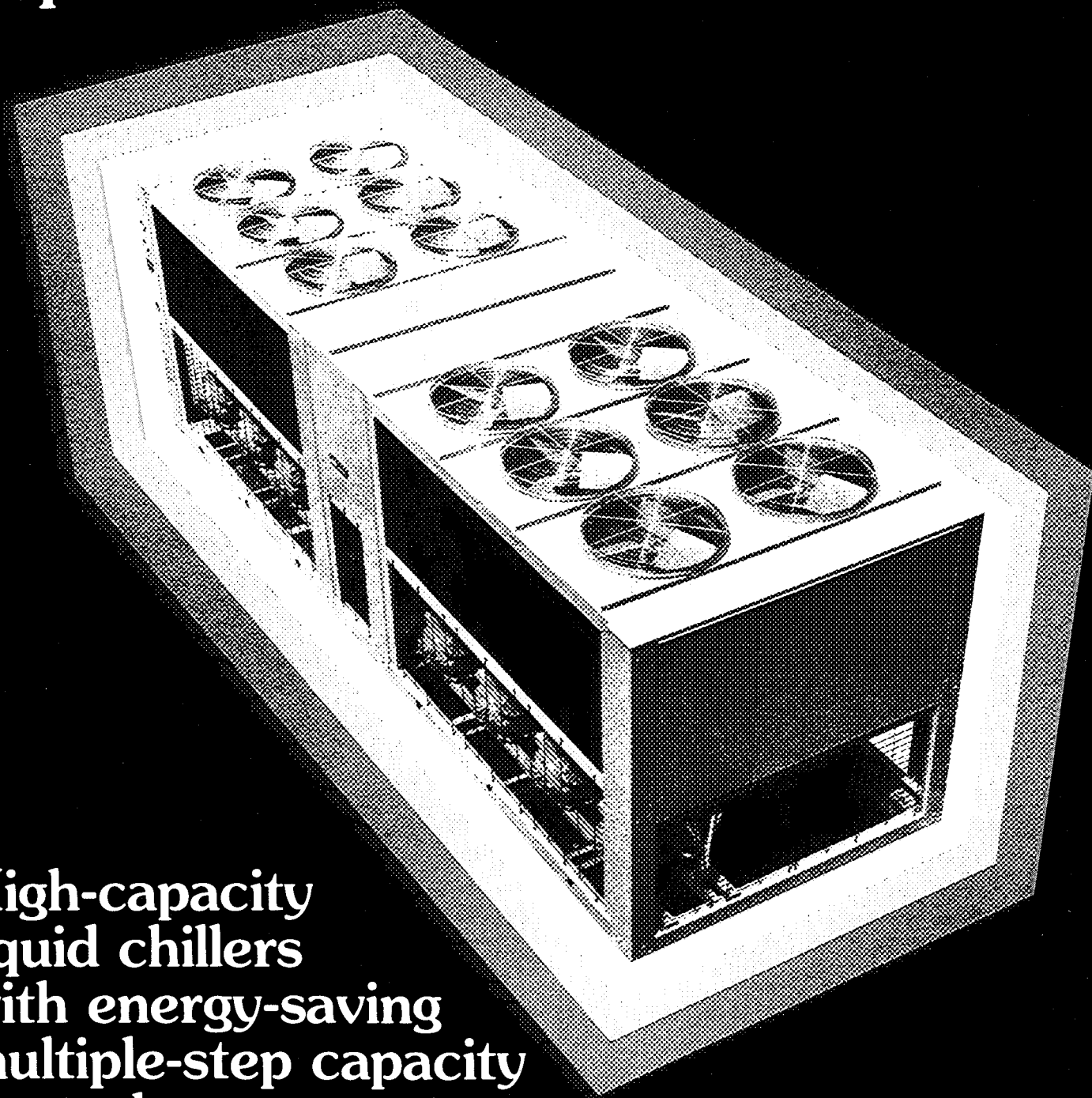

High-capacity  
liquid chillers  
with energy-saving  
multiple-step capacity  
control

*Carrier*

# The 30GB chillers provide multiple unit capacity with single-package economy

Carrier's 30GB units deliver 150, 175 or 200 tons of liquid chilling capacity in a single enclosure. Compact size allows faster rigging, installation and setup on the ground or on the roof. Units arrive assembled and fully charged with R-22. A simple hookup to power supply and chilled water lines completes the installation.

The 30GB line saves operating costs with precise multiple step capacity control. Either 6, 7 or 8 steps of control, depending on the unit, allows load handling to 12-1/2% of total capacity. Condenser coils are circuited for maximum subcooling, increasing unit capacity 1% for each 2 degrees of subcooling with no increase in power input or need for larger, costlier compressors. Multiple condenser fans cycle

automatically to maintain positive head pressure for low ambient operation down to 0°F without additional controls to purchase!

The 30GB chillers perform reliably on the job, too. Compressors are mounted on spring-isolated rails to minimize vibration, eliminating the need for external isolation. All controls and factory wiring are protected within weather-resistant, galvanized steel enclosures. Fan guards are PVC-coated steel wire for weather resistance.

Put Carrier's high capacity liquid chillers to work on your large commercial job. The cost-saving advantages of fast installation, controlled capacity operation, and low maintenance really add up to superior performance.

## Carrier's serviceable semi-hermetic compressor is protected by unique five-way system

- 1. Ground current sensing refrigerant circuit protection.** An electronic sensing device automatically shuts down a compressor if an electrical phase imbalance greater than 2.5 amps occurs due to compressor motor malfunction, thus preventing refrigerant system contamination.
- 2. Overtemperature protection.** Discharge gas thermostat, located in the cylinder head of each compressor, triggers a refrigerant circuit shutdown if temperature becomes abnormally high, preventing compressor failure.
- 3. Electrical overload protection.** Calibrated, ambient-compensated, magnetic-trip circuit breakers with manual reset provide single-phase and phase reversal protection.
- 4. Oil-pressure safety switch.** A switch in each refrigerant circuit protects compressors from damage due to lack of proper lubrication.
- 5. High-pressure switch.** A switch mounted on each compressor shuts off the compressor if discharge pressure becomes excessive.

### Additional compressor features:

- |   |                                    |
|---|------------------------------------|
| <b>1</b> Vane-type positive displacement oil pump             | <b>6</b> Discharge valve assembly  |
| <b>2</b> Motor-compressor crankshaft                          | <b>7</b> Crankcase oil heater      |
| <b>3</b> Discharge shutoff valve                              | <b>8</b> Isolation springs         |
| <b>4</b> Terminal box   | <b>9</b> High-pressure switch      |
| <b>5</b> Oil reservoir showing oil screen and oil intake line | <b>10</b> Discharge gas thermostat |

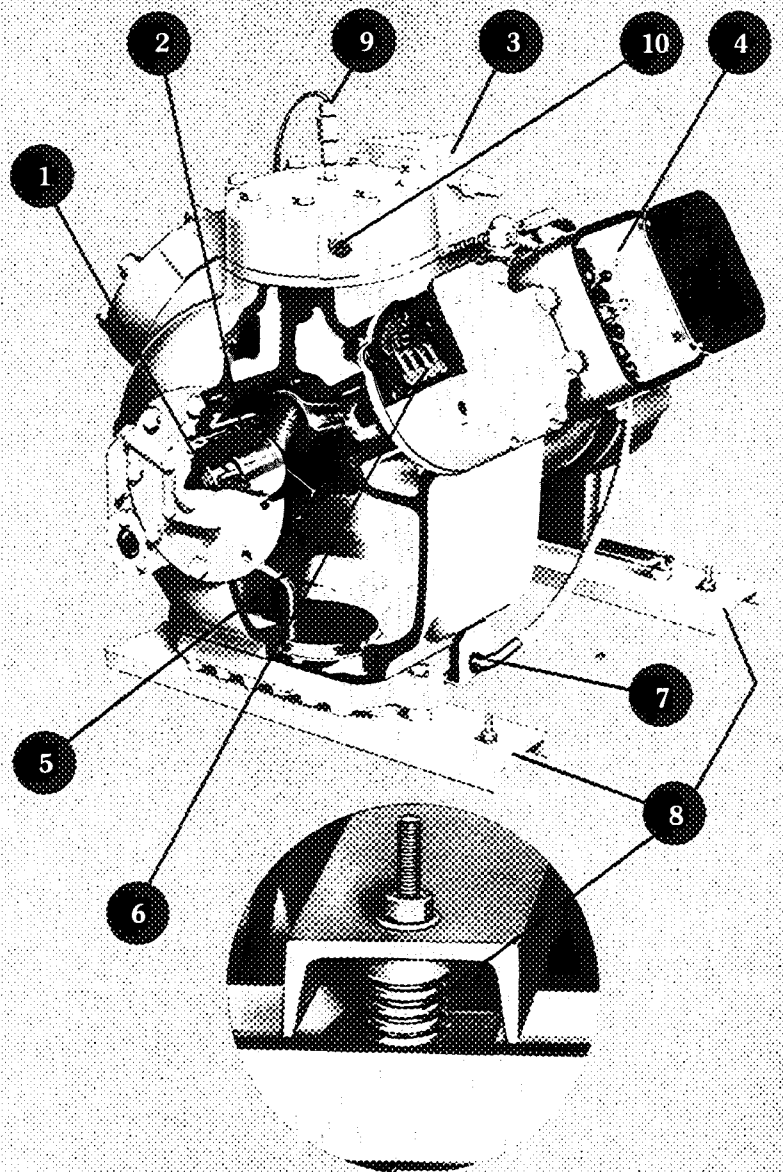

# The Carrier 30GB chillers offer more features for more cost-saving flexibility

## Cooler freeze-up protection

Each unit is protected against cooler freeze-up by 2 methods. A low-water temperature safety thermostat stops the unit automatically if water temperature drops below 36F. By the second method, factory-installed heaters protect the cooler from the effects of sub-freezing ambient temperatures. These heaters are located around the shell, between the shell and a thick layer of closed-cell insulation; they are energized whenever the chilled water flow stops.

## Compressor crankcase heaters

Each compressor has an electric heater that operates only during periods of compressor shutdown to assure proper lubrication by minimizing refrigerant dilution of oil.

## Easy access to components

All electrical components are accessible thru removable service panels. Cooler and compressor are protected by removable steel wire guards. Carrier also provides a handy convenience outlet (115v) for connecting lights and power tools.

## Standby protection

Multiple compressor operation offers system reliability in case of a malfunction or safety cutout. Dual, independent refrigerant circuits maintain partial unit capacity even if one circuit fails. This backup protection can help prevent costly damage in process cooling or industrial applications.

## Flow switch

Chilled water flow switch shuts down the unit and energizes the cooler heaters in case chilled water flow stops.

## Units meet NEMA-MGI motor standards

All compressor and fan motors meet National Electrical Manufacturer's Association and U.S. government standards.

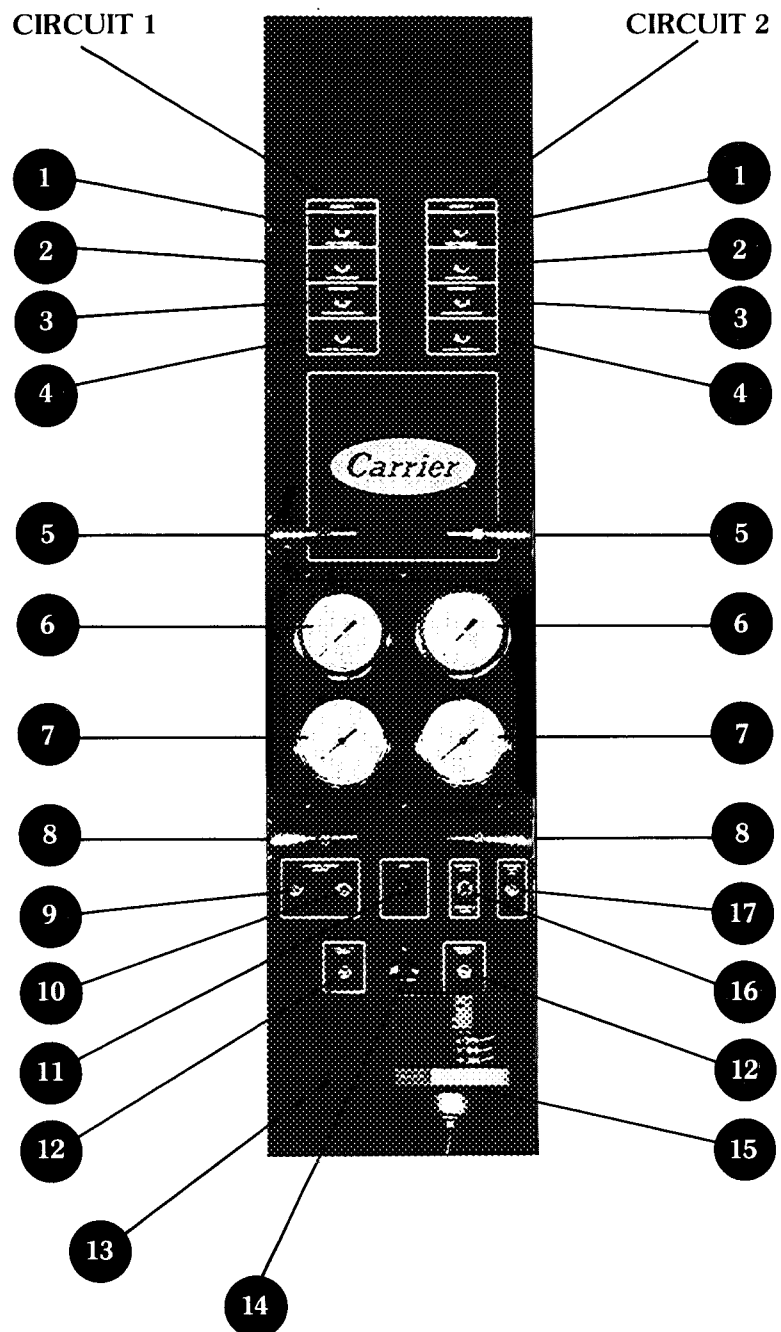

- |   |                                |    |   |
|---|--------------------------------|----|---|
| 1 | High-pressure light            | 10 | Control power ON-OFF switch                 |
| 2 | Low-pressure light             | 11 | Control circuit fuse                        |
| 3 | Discharge temperature light    | 12 | Reset button (control circuit)              |
| 4 | Oil-pressure light             | 13 | Reset button (low water temperature cutout) |
| 5 | Valve, discharge pressure gage | 14 | Convenience outlet (115 volts)              |
| 6 | Discharge pressure gage        | 15 | Temperature controller                      |
| 7 | Suction pressure gage          | 16 | Lead/lag transfer switch                    |
| 8 | Valve, suction pressure gage   | 17 | Demand limit light                          |
| 9 | Control power light            |    |   |

# Dimensions

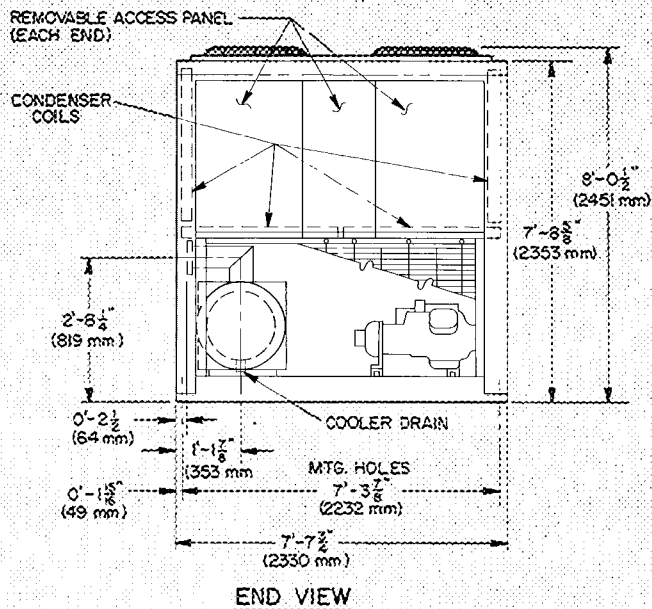
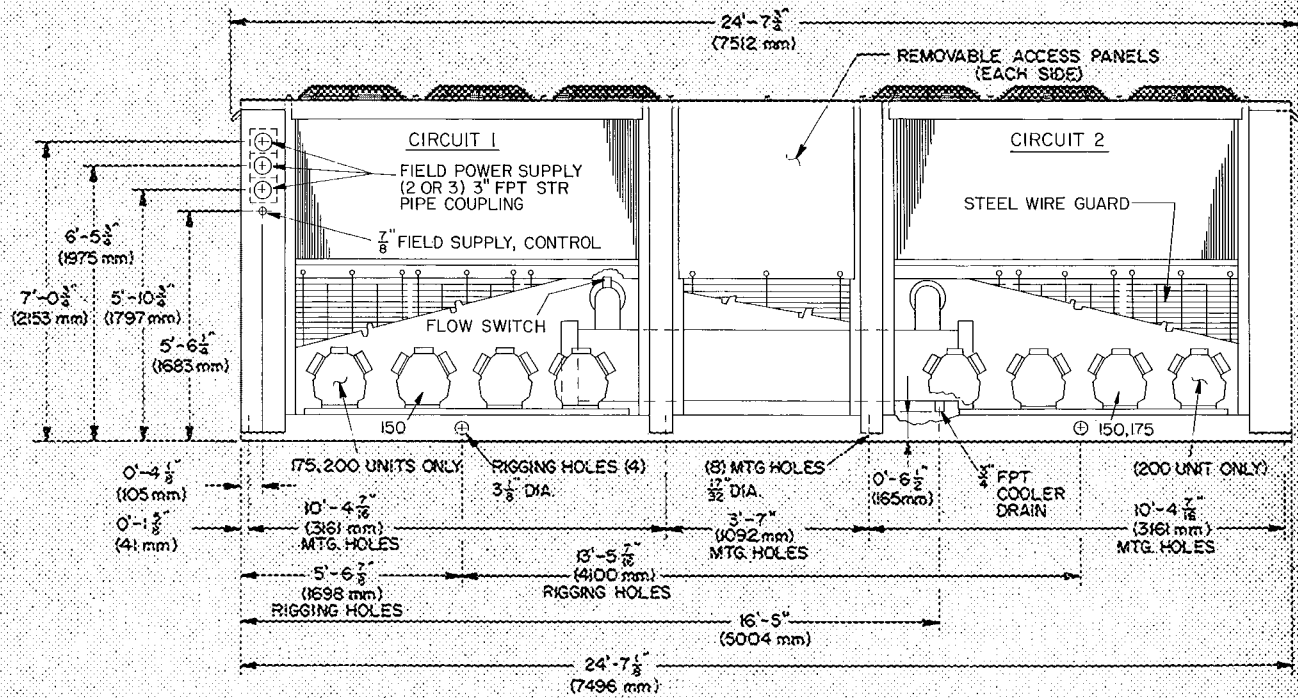
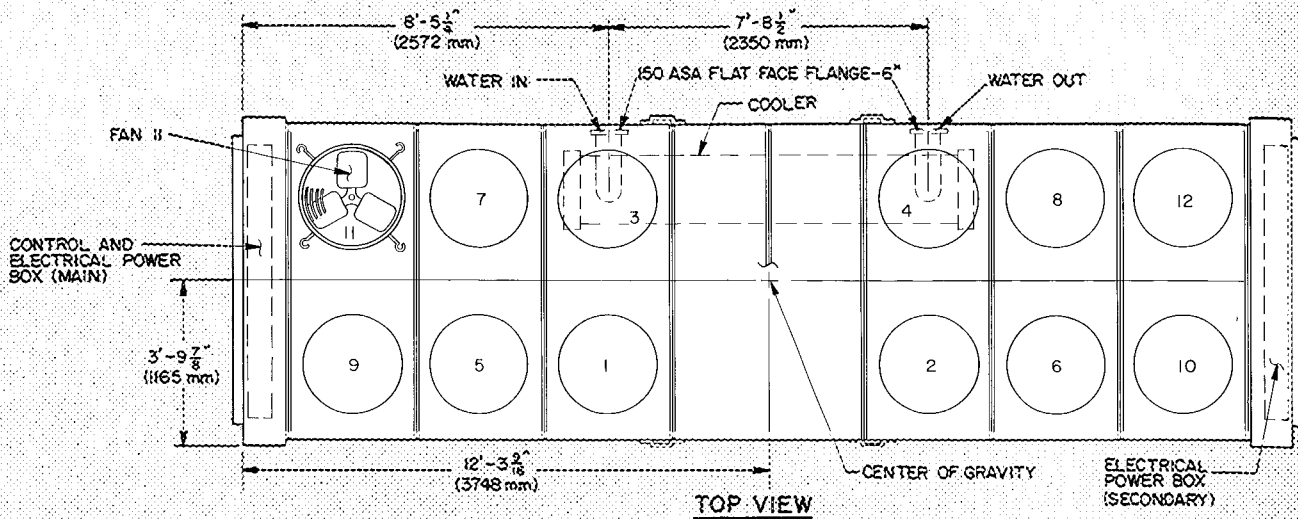

Unit must have clearances as follows:  
 Top — Do not restrict in any way  
 Ends — 5'0" (1524 mm)  
 Sides — 10'0" (3048 mm)

# Physical data (60-Hz)

UNIT 30GB	150	175	200
APPROX OPER WT (lb)	14,100	14,600	15,100
REFRIGERANT CHARGE, R-22 (lb)	230/ckt	230/ckt	230/ckt
COMPRESSORS (Type...Rpm)	Reciprocating, Semi-Hermetic 1750		
06E (No.) Circuit 1	(3) F275	(4) F275	(4) F275
(No.) Circuit 2	(3) F275	(3) F275	(4) F275
Cap. Control Steps	6	7	8
% Cap. Circuit 1	50	57	50
Circuit 2	50	43	50
Minimum Step Capacity (%)	16.7	14.3	12.5
CONDENSER FANS	3-Blade Propeller, Direct Drive		
No. . . Diameter (in )	12 30		
Rpm . Total Kw	1140 18.6		
Total Airflow (cfm)	117,600		
CONDENSER COILS	13.5 Fins/in 1/2-in OD Copper Tube		
Condenser	Lead	Lag	Lead
No. Rows Ckt 1	4	4	4
Ckt 2	4	4	4
Face Area Ckt 1	60.5	60.5	60.5
Ckt 2	60.5	60.5	60.5
COOLER, 10HA400504	One Direct Expansion Shell and Tube		
No. Refrigerant Circuits	2		
Net Water Volume (gal )	60.2 (Includes nozzles)		
Maximum Working Pressure (psig)	Refrigerant Side 235, Water Side: 150		
WATER CONNECTIONS (in )	6 150-lb ASA Flat Face Flange		
Inlet and Outlet	3/4 FPT		
Drain			

## 30GB150-200

### TOP VIEW – FAN AND COMPRESSOR LOCATIONS; FAN OPERATION

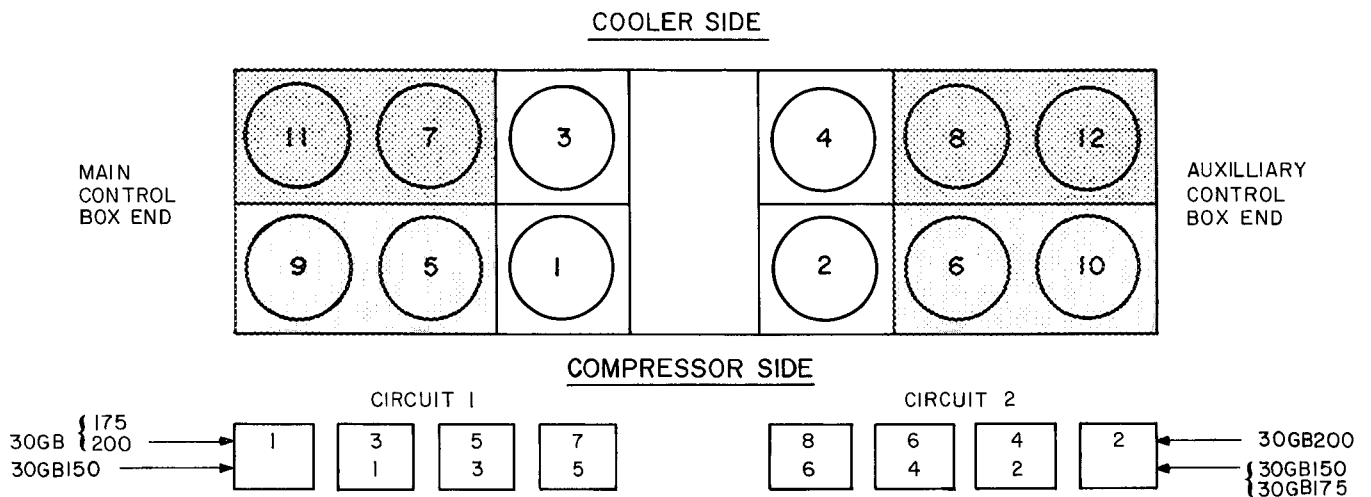

FAN CONTACTOR NO.	CONTROLS FAN NO.	CONTROLLED BY:
CIRCUIT 1	1	ALWAYS RUNS WITH COMPR NO 1
FC1	3	TEMPERATURE & CHR5 (Ambient over 70 F)
FC3	7 & 11	PRESSURE: Closes 260, opens 160 psig
FC5	5 & 9	TEMPERATURE: Closes at 70 F
FC7		
CIRCUIT 2	2	ALWAYS RUNS WITH COMPR NO 2
FC2	4	TEMPERATURE & CHR6 (Ambient over 70 F)
FC4	8 & 12	PRESSURE: Closes at 260 psig, opens 160 psig
FC6	6 & 10	TEMPERATURE: Closes at 70 F
FC8		

# Selection procedure (with example)

## I Determine job requirements.

Given:

Cooling Load ..... 190 Tons  
 Leaving Chilled Water Temperature (LCWT) ... 45 F  
 Chilled Water System ΔT ..... 10 F  
 Cooler Fouling Factor ..... 0.0005  
 Condenser Entering Air Temperature (CEAT) ... 95 F

## II Select unit to provide cooling load capacity.

Enter Performance Ratings table at 95 F CEAT and 45 F LCWT. Under Cap., 196.7 tons is nearest to and greater than the given cooling load (190 tons). Read unit selection and performance data directly from table:

Unit ..... 30GB200  
 Capacity (Cap.) ..... 196.7 Tons  
 Saturated Discharge Temp (SDT) ..... 130.9 F  
 Compressor Power Input (Kw) ..... 246.3 Kw  
 Cooler Flow Rate (Gpm) ..... 471.0 gpm  
 Cooler Pressure Drop (PD) ..... 12.5 ft water

# Performance data

## Ratings

The following ratings tables are based on 10 F chilled water rise, 0.0005 fouling factor in cooler, and Refrigerant 22. **Ratings in boldface type** are in accordance with ARI Standard 590-76. The conditions are 95 F Condenser Entering Air Temperature (dry-bulb), 44 F Leaving Chilled Water Temperature.

- Cap. — Capacity
- Kw — Compressor Motor Power Input
- LCWT — Leaving Chilled Water Temp
- PD — Pressure Drop (ft water)
- SDT — Sat Disch Temp

PERFORMANCE RATINGS (10F Chilled Water Rise)

LCWT	UNIT 30GB	CONDENSER ENTERING AIR TEMPERATURE														
		85						90						95		
		Cap. (Tons)	SDT (F)	Compr Kw	Cooler Flow Data		Cap. (Tons)	SDT (F)	Compr Kw	Cooler Flow Data		Cap. (Tons)	SDT (F)	Compr Kw	Cooler Flow Data	
			Gpm	PD				Gpm	PD				Gpm	PD		
40	150	153.0	114.7	164.7	365.7	7.6	147.5	119.1	169.2	352.6	7.1	142.1	123.4	173.5	339.7	6.6
	175	173.4	117.4	193.5	414.4	9.7	167.4	121.7	198.5	400.1	9.1	161.4	125.9	203.2	385.7	8.5
	200	191.1	119.2	220.8	456.9	11.7	194.4	123.4	226.1	440.9	11.0	177.8	127.6	231.2	425.1	10.2
42	150	159.4	115.9	168.7	381.2	8.3	153.6	120.2	173.4	367.8	7.7	148.2	124.5	177.8	354.6	7.2
	175	180.6	118.7	198.4	432.1	10.5	174.4	122.9	203.5	417.1	9.8	168.1	127.1	208.3	402.2	9.2
	200	198.9	120.5	226.3	475.7	12.7	192.0	124.7	231.9	459.3	11.9	185.3	128.9	237.2	443.2	11.1
44	150	165.9	117.1	172.6	397.1	8.9	160.2	121.4	177.5	383.4	8.4	154.5	125.7	182.2	369.8	7.8
	175	188.0	119.9	203.3	450.0	11.4	181.5	124.2	208.5	434.5	10.6	175.2	128.4	213.6	419.8	9.9
	200	206.8	121.8	231.9	494.9	13.7	199.7	126.0	237.8	478.1	12.8	192.8	130.2	243.3	461.6	12.0
45	150	169.2	117.7	174.6	405.1	9.3	163.4	122.0	179.7	391.3	8.7	157.6	126.2	184.4	377.5	8.1
	175	191.7	120.6	205.7	459.0	11.8	185.2	124.8	211.1	443.5	11.1	178.7	129.0	216.2	427.9	10.3
	200	210.7	122.5	234.7	504.5	14.2	203.6	126.7	240.6	487.5	13.3	196.7	130.9	246.3	471.0	12.5
46	150	172.5	118.3	176.7	413.3	9.7	166.7	122.5	181.8	399.3	9.0	160.9	126.8	186.6	385.4	8.4
	175	195.3	121.2	208.2	467.9	12.3	188.9	125.5	213.7	452.4	11.5	182.3	129.7	218.9	436.7	10.8
	200	214.7	123.2	237.6	514.2	14.8	207.7	127.4	243.7	497.4	13.8	200.5	131.5	249.3	480.3	12.9
48	150	179.3	119.5	180.8	429.8	10.4	173.3	123.7	186.0	415.3	9.8	167.3	128.0	191.0	401.0	9.1
	175	203.1	122.6	213.3	486.7	13.3	196.3	126.8	218.9	470.5	12.4	189.7	131.0	224.4	454.6	11.6
	200	222.9	124.6	243.4	534.1	15.9	215.7	128.7	249.7	517.0	14.9	208.4	132.9	255.6	499.5	13.9

LCWT	UNIT 30GB	CONDENSER ENTERING AIR TEMPERATURE														
		105						110						115		
		Cap. (Tons)	SDT (F)	Compr Kw	Cooler Flow Data		Cap. (Tons)	SDT (F)	Compr Kw	Cooler Flow Data		Cap. (Tons)	SDT (F)	Compr Kw	Cooler Flow Data	
			Gpm	PD				Gpm	PD				Gpm	PD		
40	150	131.4	132.1	181.5	314.2	5.7	126.1	136.4	195.0	301.4	5.2	120.7	140.7	188.4	288.5	4.8
	175	149.1	134.4	211.8	356.4	7.3	143.1	138.7	215.7	342.1	6.7	137.2	143.0	219.5	328.0	6.2
	200	164.7	136.1	240.6	393.7	8.8	156.3	140.3	244.7	377.9	8.1	151.6	144.5	248.8	362.3	7.5
42	150	137.2	133.2	186.1	328.2	6.2	131.7	137.5	199.9	315.1	5.7	126.3	141.8	193.5	302.1	5.3
	175	155.7	135.6	217.4	372.4	7.9	149.6	139.9	221.6	357.8	7.3	143.5	144.1	225.6	343.3	6.7
	200	171.9	137.3	247.0	411.1	9.6	165.2	141.5	251.5	395.1	8.9	158.4	145.7	255.7	378.9	8.2
44	150	143.2	134.3	190.8	342.8	6.7	137.6	138.6	194.9	329.4	6.2	132.0	142.9	198.7	316.0	5.7
	175	162.4	136.8	223.0	388.7	8.6	156.1	141.1	227.4	373.6	7.9	149.9	145.3	231.7	358.9	7.4
	200	179.3	138.6	253.7	429.1	10.4	172.3	142.8	258.2	412.4	9.6	165.4	147.0	262.7	396.0	8.9
45	150	146.2	134.8	193.2	350.1	7.0	140.6	139.1	197.3	336.6	6.5	134.8	143.4	201.2	322.8	6.0
	175	165.8	137.4	225.9	397.0	8.9	159.4	141.7	230.4	381.8	8.3	153.2	145.9	234.8	366.8	7.7
	200	183.0	139.3	256.9	438.1	10.8	175.9	143.4	261.6	421.1	10.0	169.0	147.6	266.2	404.6	9.3
46	150	149.3	135.4	195.6	357.6	7.3	143.5	139.7	199.8	343.8	6.8	137.7	144.0	203.8	329.9	6.2
	175	169.3	138.1	228.9	405.6	9.3	162.8	142.3	233.4	390.0	8.6	156.5	146.5	237.8	374.7	8.0
	200	186.7	139.9	260.3	447.2	11.3	179.5	144.1	265.0	430.0	10.4	172.5	148.2	269.8	413.3	9.7
48	150	155.6	136.6	200.5	372.8	7.9	149.6	140.9	204.9	358.6	7.3	143.7	145.1	209.1	344.4	6.8
	175	176.4	139.4	234.7	422.7	10.1	169.6	143.5	239.4	406.5	9.4	163.1	147.8	244.1	391.0	8.7
	200	194.3	141.2	267.0	465.7	12.2	187.1	145.4	272.0	448.4	11.3	179.8	149.5	276.9	430.9	10.5

**TOTAL COOLER PRESSURE DROP**  
10HA400504 Cooler

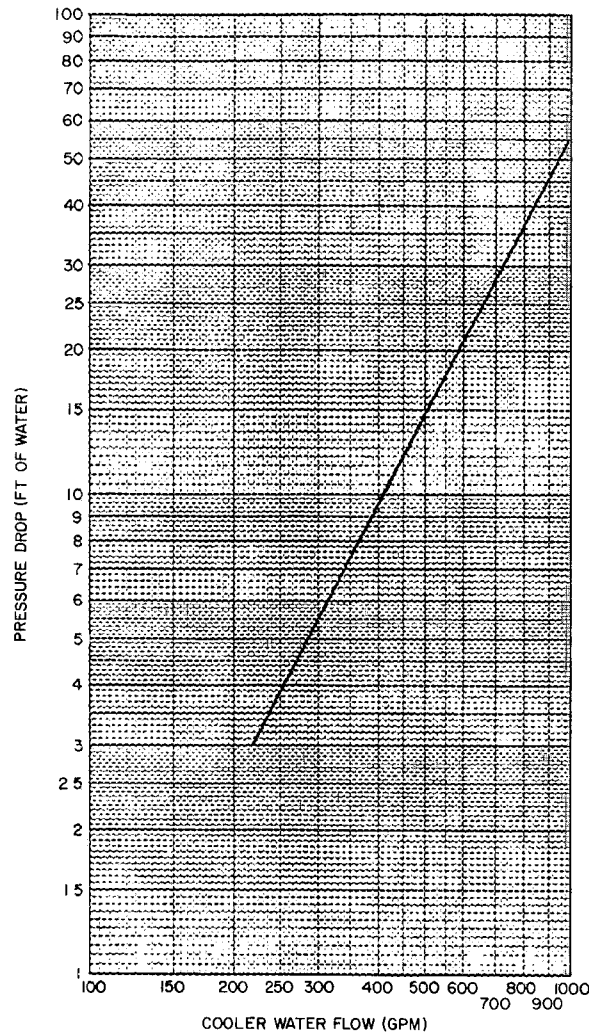

## Electrical data (60-Hz)

30GB	Model	UNIT				COMPRESSORS†						FAN MOTORS‡				CONTROLS	
		Volts		Type of Start	MCA	MFA	ICF	RLA (ea)	LRA (ea)	MTA (CB)	Total Kw	Ph	FLA (ea)	MTA** (FCB)	Hp (NEC)	Kw	
		Name-plate	Supplied*														Min
150	500	208-230	187	253	XL	767	1000	1136	110	506	154	18.6	3	6.6	74	1.94	0.27
	600	460	414	508	XL	362	450	550	52	253	73	18.6	3	3.0	28	1.75	0.27
	100	575	518	632	XL	310	400	430	45	176	63	18.6	3	2.4	22	1.75	0.27
175	500	208-230	187	253	XL	877	1000	1246	110	506	154	18.6	3	6.6	74	1.94	0.27
	600	460	414	508	XL	414	500	602	52	253	73	18.6	3	3.0	28	1.75	0.27
	100	575	518	632	XL	355	400	475	45	176	63	18.6	3	2.4	22	1.75	0.27
200	500	208-230	187	253	XL	987	1200	1356	110	506	154	18.6	3	6.6	74	1.94	0.27
	600	460	414	508	XL	466	600	654	52	253	73	18.6	3	3.0	28	1.75	0.27
	100	575	518	632	XL	400	450	520	45	176	63	18.6	3	2.4	22	1.75	0.27

- CB** — Circuit Breaker
- FCB** — Fan Circuit Breaker
- FLA** — Full Load Amps (Fan Motors)
- Hp** — Horsepower
- ICF** — Maximum Instantaneous Current Flow during starting (the point in the starting sequence where the sum of the LRA for the starting compressor, plus the total RLA for all running compressors, plus the total FLA for all running fan motors is maximum)
- Kw** — Total condenser fan motor power input
- LRA** — Locked Rotor Amps
- MCA** — Minimum Circuit Amps (for wire sizing) Complies with NEC Section 430-24
- MFA** — Maximum Fuse Amps (Maximum overcurrent protective device amps)

- MTA** — Must Trip Amps (Circuit Breaker)
- NEC** — National Electrical Code
- Ph** — Phase
- RLA** — Rated Load Amps (Compressors)
- XL** — Across-the-Line

\*Units are suitable for use on electrical systems where voltage supplied to the unit terminals is not below or above the listed minimum and maximum limits  
 †30GB150 has 6 compressors; 30GB175 has 7 compressors; 30GB200 has 8 compressors  
 ‡Each unit has 12 fans  
 \*\*Each unit has 2 fan circuit breakers; 6 fans are protected by each FCB

# Electrical data (60-Hz) (cont)

## General electrical notes

1. The 115-1-60 control circuit power must be supplied from a separate source, thru a field-supplied 30-amp fused disconnect.
2. Crankcase and cooler heaters are wired into the control circuit so they are always operable as long as the control circuit power supply disconnect is on, even if any safety device is open or the unit ON-OFF switch is off.
3. Heaters are wired ahead of the control circuit fuse; thus, they are protected by the 30-amp overcurrent protective device in the control circuit power supply.

## Start-up sequence

The control power switch is off and all crankcase heaters and cooler heaters are energized.

The chilled water pump (CWP) must be turned on before the control circuit can be energized.

When the chilled water begins circulating, the flow switch (CWFS) closes. The cooler heater cable (CHC) is de-energized and the flow relay is energized.

When the control circuit switch is turned on, the 115-volt control circuit and parts of the 24-volt circuit are energized. The SC cycles back to the completely unloaded position and unit start-up can proceed.

4. All units have single-point power connection to simplify field-power wiring.
5. The 208-230/3/60 units have 3 terminal blocks and require 9 parallel conductors from the disconnect
6. The 460 and 575/3/60 units have 2 terminal blocks and require 6 parallel conductors from the disconnect.
7. Maximum incoming wire size for each terminal block is 500 MCM.
8. The 208-230-volt 30GB200 units must have copper main power conductors to meet NEC requirements.

**Circuit no. 1** (start-up of lead compressor) — With the temperature controller (TC) calling for cooling, SW1 in the SC makes and no. 1 condenser fan starts. If the ambient is over 70F, fans no. 5 and 9 start; fans no. 7 and 11 start after compressor no. 1 starts and the discharge pressure exceeds 260 psig.

**Relay no. 1 (R1)** and the rest of the 24-volt circuit are energized. The start-up function continues as follows (refer to LEGEND for identification of components):

### LEGEND

CH — Crankcase Heater  
 CHC — Cooler Heater Cable  
 CHR — Crankcase Heater Relay  
 CLO — Compressor Lockout  
 CR — Control Relay  
 CWFS — Chilled Water Flow Switch  
 CWP — Chilled Water Pump  
 DGT — Discharge Gas Thermostat

DTR — Discharge Temperature Relay  
 FLR — Flow Relay  
 HPR — High-Pressure Relay  
 HPS — High-Pressure Switch  
 LLS — Liquid Line Solenoid Valve  
 LOR — Lock-Out Relay  
 LPR — Low-Pressure Relay  
 LPS — Low-Pressure Switch

OPR — Oil-Pressure Relay  
 OPS — Oil-Pressure Switch  
 R — Relay  
 SC — Step Controller  
 SW — Switch  
 TC — Temperature Controller  
 TD — Time Delay

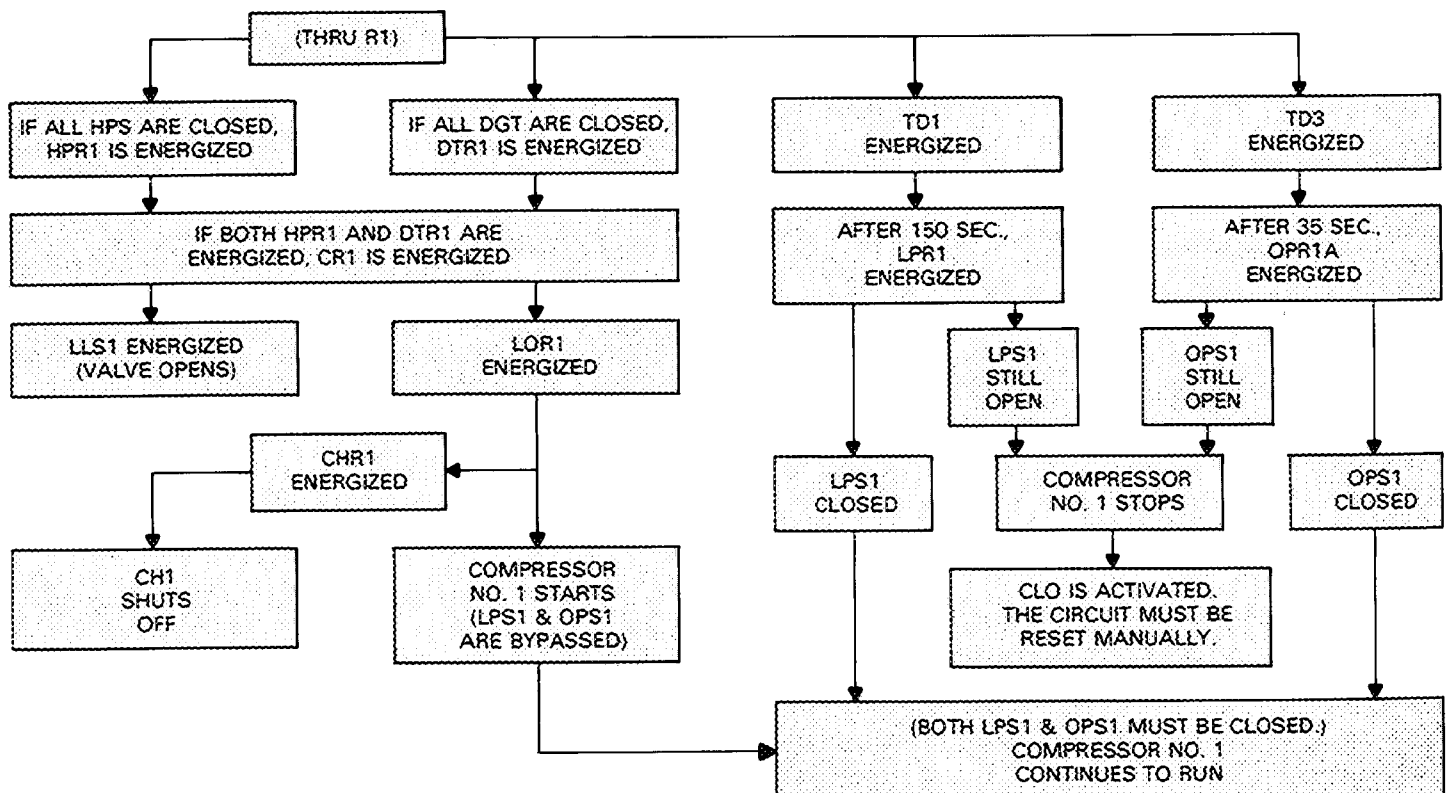



**Circuit no. 2 (start-up of lead compressor)**

As the TC continues to call for cooling, SW2 in the SC makes. As in circuit no. 1, circuit no. 2 is energized and compressor no 2 starts thru a sequence of electrical functions which are a duplication of circuit no. 1. Also, condenser fans no 2, 6, 10, 8 and 12 start

With the lead compressor in each circuit running, and the TC still calling for cooling, the start-up continues:

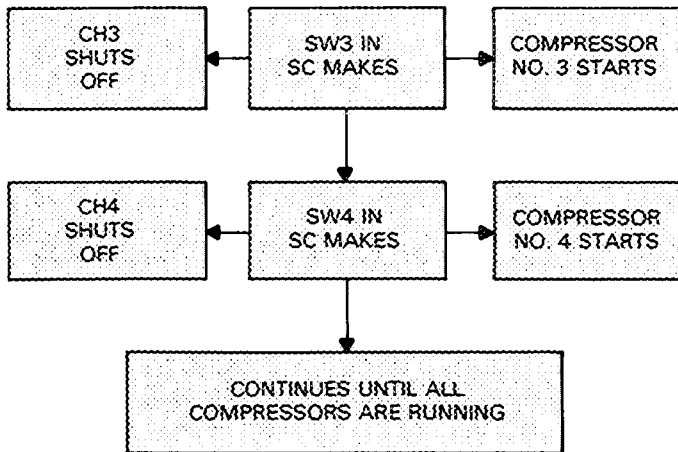

When compressor no. 5 starts, condenser fan no. 3 starts, if ambient is over 70 F; when compressor no. 6 starts, condenser fan no 4 starts, if ambient is over 70 F.

The unit is now running at full load with all compressors and fans operating.

**Operation as load is decreased**

As the demand for cooling decreases, the unit shuts down thru the following steps:

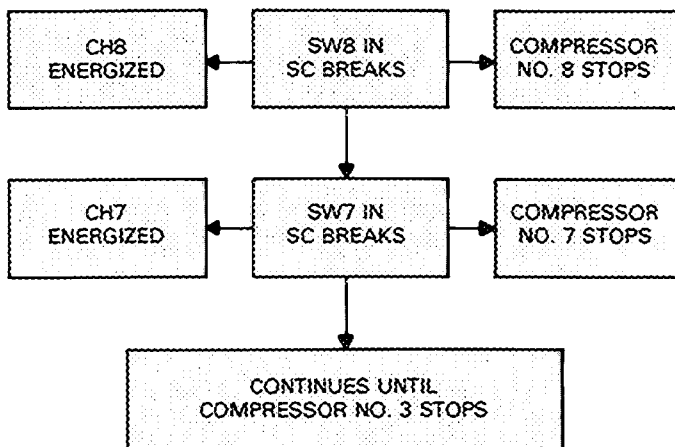

When compressor no. 6 stops, condenser fan no. 4 stops and when compressor no. 5 stops, condenser fan no 3 stops.

**Circuit no. 2 shuts down**

As cooling load continues to decrease:

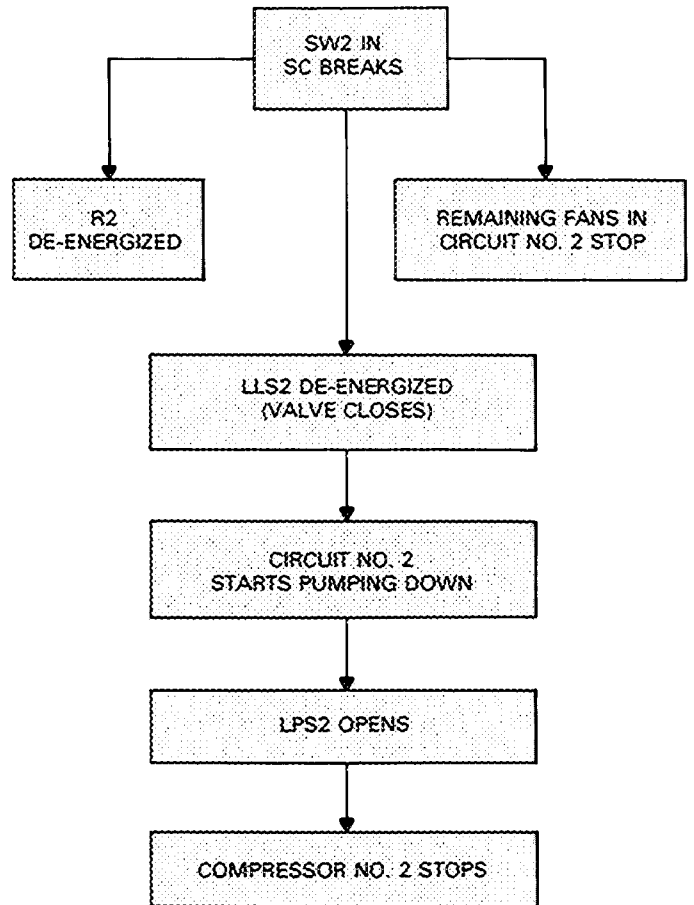

**Circuit no. 1 shuts down**

Cooling load continues to decrease:

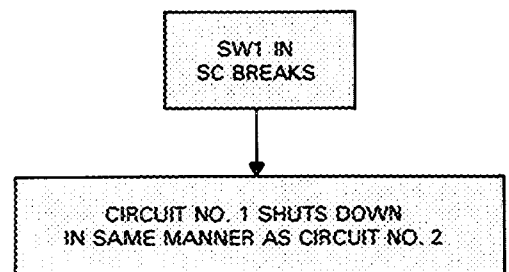

The unit is now cycled off, ready to restart under TC control when additional cooling is needed.

# Application data

## Unit performance with external static on condenser fans

Every effort should be made to install unit where the condenser airflow above the unit is unrestricted. If this is not possible, unit performance is affected and data must be corrected as follows:

### EXTERNAL STATIC CORRECTION FACTORS

EXTERNAL STATIC (in. wg)	% CFM DECREASE	CAPACITY MULTIPLIER	KW MULTIPLIER
0.10	8.5	0.986	1.014
0.20	17.5	0.968	1.031

## Cooler fouling factor correction

FOULING FACTOR	CAPACITY MULTIPLIER	KW MULTIPLIER
0.0005	1.00	1.00
0.001	0.97	0.98
0.002	0.91	0.94

Corrected Cap. = Rated Cap. x Cap. Corr Factor

Corrected Kw = Rated Kw x Kw Corr Factor

Corrected Gpm =  $\frac{\text{Corrected Cap. (tons)} \times 24}{\Delta T (F)}$

**Low-ambient operation** — The minimum ambient temperature at which the unit will start and build up head pressure on the first and second steps of capacity is 20°F. After operation is established, the minimum operating temperature is approximately 0°F.

Field-installed chilled water piping may be protected at lower ambients by wrapping with field-supplied heating cable and covered with 2-in. thick closed cell insulation.

It is strongly recommended that ethylene glycol be used in installations where sub-freezing temperatures are expected.

Unit performance data must be corrected as shown in the following example:

### I Determine concentration of ethylene glycol required to protect system to -10°F (at zero flow).

Given:

Unit ..... 30GB200  
 Condenser Entering Air Temperature (CEAT) ... 95°F  
 Leaving Chilled Water Temperature (LCWT) ... 45°F  
 Chilled Water System ΔT ..... 10°F  
 Capacity ..... 196.7 Tons  
 Chilled Water Flow Rate ..... 471.0 gpm  
 Cooler Pressure Drop ..... 12.5 ft water  
 Compressor Power Input ..... 246.3 Kw

From curve, read 40% concentration is required for solution crystallization at -10°F.

### II Correct unit capacity.

From curve, read 0.983 capacity correction at 40% concentration.

Corrected Capacity = 0.983 x Given Capacity  
 = 0.983 x 196.7 Tons  
 = 193.4 Tons

### III Correct chilled water flow rate.

From curve, read 1.097 gpm correction at 40% concentration.

$$\text{Chilled Water Flow (at corrected Cap.)} = \frac{\text{Tons} \times 24}{\Delta T} = \frac{193.4 \times 24}{10} = 464.2 \text{ gpm}$$

$$\begin{aligned} \text{Ethylene Glycol Flow (40\% solution)} &= \text{water flow} \times 1.097 \\ &= 464.2 \times 1.097 \\ &= 509.2 \text{ gpm} \end{aligned}$$

### IV Correct cooler pressure drop.

From curve, read 1.185 cooler pressure drop correction at 40% concentration. From cooler pressure drop curve, for 509.2 gpm of water, pressure drop = 14.7 ft water. PD for 40% ethylene glycol solution = 1.185 x 14.7 = 17.4 ft water.

### V Reduction in compressor power input (Kw) is insignificant.

## ETHYLENE GLYCOL PERFORMANCE CORRECTION FACTORS AND SOLUTION CRYSTALLIZATION POINTS

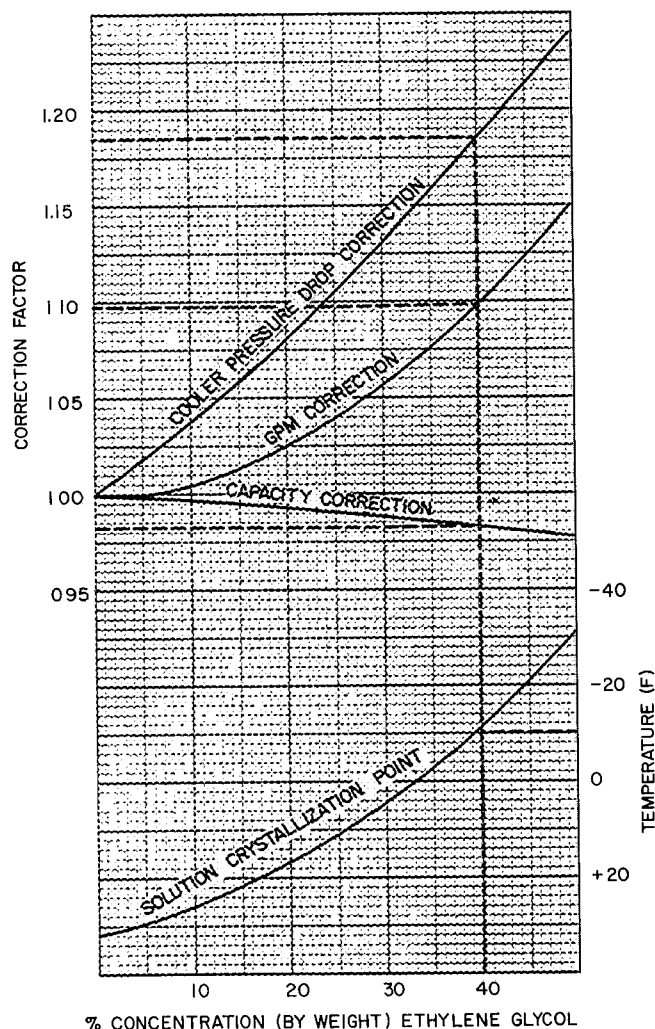

# Guide specifications

**Furnish and install** factory-assembled, one-piece Carrier 30GB packaged air-cooled liquid chiller(s). Unit(s) shall be completely factory charged with Refrigerant 22. All factory wiring and piping shall be contained within the unit enclosure. All electrical components shall be mounted in a rain-tight enclosure. The exterior sheet metal shall be galvanized steel, zinc phosphatized, with an electrostatically applied, high solids polyester, baked enamel finish.

**Capacity of unit(s)** shall be not less than \_\_\_\_\_ tons, cooling \_\_\_\_\_ gpm of water from \_\_\_\_\_ F to \_\_\_\_\_ F, air entering the condenser at \_\_\_\_\_ F. Cooling fouling factor shall be \_\_\_\_\_. Unit power input shall not exceed \_\_\_\_\_ kw.

**Unit electrical power** shall be \_\_\_\_\_ volts, 3-phase, 60-Hz. Unit shall be capable of operating within line voltage limits of \_\_\_\_\_ to \_\_\_\_\_ volts. Control power shall be provided by a separate 115-volt, single-phase, 60-Hz source.

**Construction and ratings** shall be in accordance with ARI Standard 590-76 and shall comply with ANSI B9.1 Safety Code, National Electrical Code (NEC) and ASME Code.

**Each compressor** shall be reciprocating, serviceable hermetic type and shall have an automatically reversible oil pump, complete with operating oil charge. Compressors shall be equipped with suction and discharge shut-off valves and shall be mounted on spring-isolated rails. Motors shall be cooled by suction gas passing around the windings and shall have overtemperature protection. Manual restart of unit shall be required after motor stoppage due to thermal overload. Each compressor shall be equipped with an insert-type crankcase heater to minimize oil dilution during shutdown periods.

**Each compressor motor** shall be operated and protected against overload by means of definite-purpose contactors and calibrated, ambient-compensated, magnetic-trip circuit breakers. The circuit breakers shall open all (3) phases in the event of overload in any one phase and shall be manual reset.

**Cooler** shall be covered by 2 layers of 3/4-in. closed cell, vapor barrier, expanded polyvinyl chloride (PVC) insulation, with a maximum "K" factor of 0.28. Heaters along the shell, under the insulation, shall protect the cooler against freeze-up.

**Refrigerant circuit components** shall include hot-gas muffler; highside pressure relief device; liquid line shut-off valve; replaceable-core filter-drier; moisture-indicating sight glass; liquid line solenoid valve; maximum operating pressure limiting thermal expansion valve.

**Air-cooled condensers** shall be circuited to provide sub-cooling. Condensers shall be constructed of 1/2-in. OD seamless copper tubes with mechanically-bonded aluminum fins, leak tested at 150 psig and pressure tested at 450 psig.

**Condenser fans and motors** — The condenser section of each unit shall have direct-drive, propeller type fans, with steel wire safety guards. Fan motors shall be 3-phase, permanently lubricated and inherently protected with corrosion-resistant fan shaft.

**Head pressure control** — Each unit shall be equipped with a head pressure control system. Condenser fans shall be cycled by a combination of discharge pressure and ambient temperature to permit unit operation to 0°F outdoor ambient at full load.

**Each unit** shall contain an electrically operated multiple-step capacity controller with a minimum of 6 steps of capacity reduction (30GB150); the 30GB175 unit shall have 7 steps and the 30GB200 shall have 8 steps. Unit capacity shall be controlled by starting and stopping compressors. The unit can be field modified for use of hot gas bypass.

**Controls** shall be factory mounted and wired in a weather-proof enclosure. It shall include a low-pressure switch for each refrigerant circuit; an electronic ground current sensing refrigerant circuit protection device for each compressor; lead-lag switch; suction and discharge pressure gages, with shut-off valves; chilled water safety thermostat; field power and control circuit terminal blocks; compressor motor and fan motor circuit breakers; motor contactors; control relays; control circuit ON-OFF switch; energy management system interface for demand-limit control. A high-pressure switch shall be factory mounted on each compressor; on the lead compressor in each circuit an oil-pressure safety switch shall be factory mounted. A chilled water flow switch shall be factory mounted on the chilled water inlet nozzle.

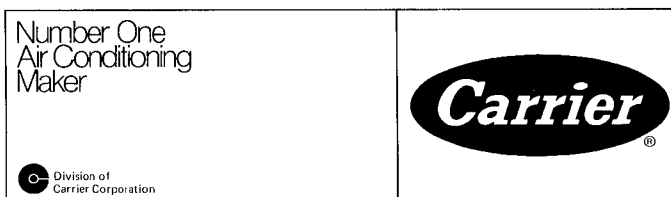

Manufacturer reserves the right to discontinue, or change at any time, specifications or designs without notice and without incurring obligations.

Book	2
Tab	5c

Form 30GB-1P New

Printed in U S A

8-81

PC 111

Catalog No 523-030